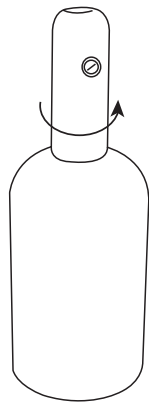
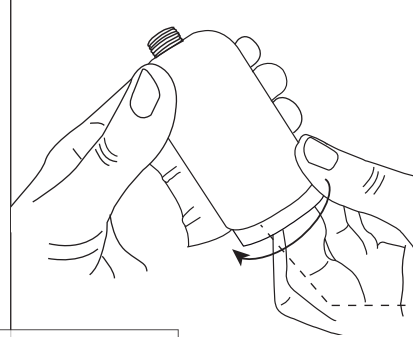
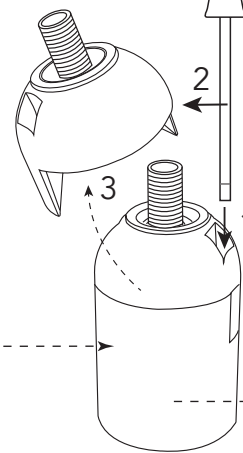
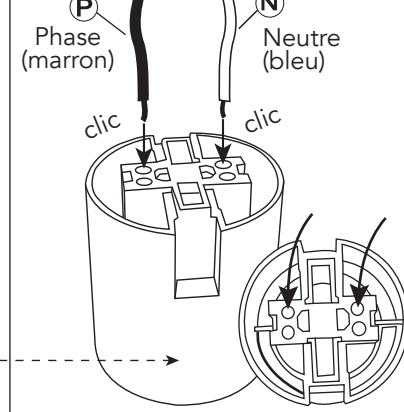
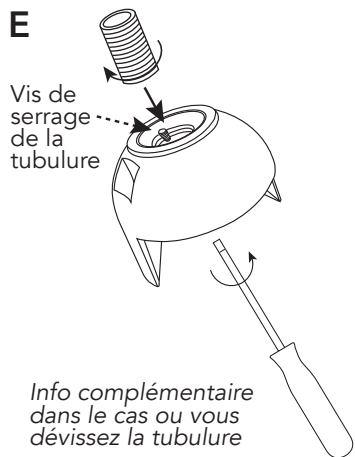
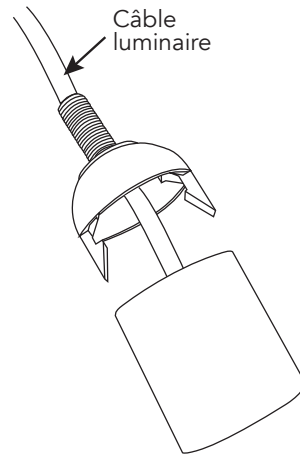
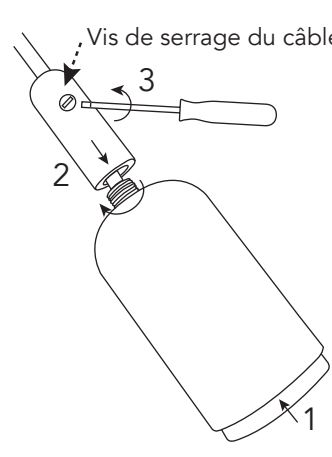

A MONTAGE

Avant de faire les branchements, coupez le courant à votre tableau électrique.

B**C****D****E**

Info complémentaire dans le cas où vous dévissez la tubulure

F**G****DEMONTAGE**