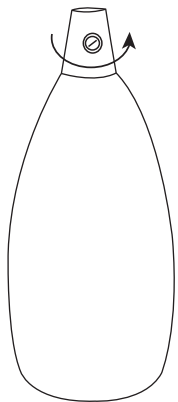
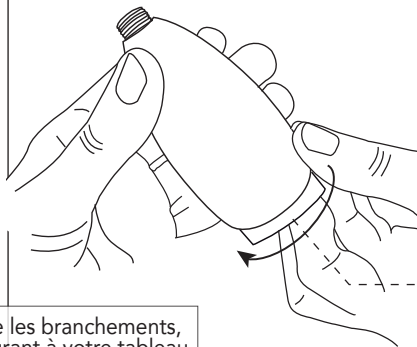
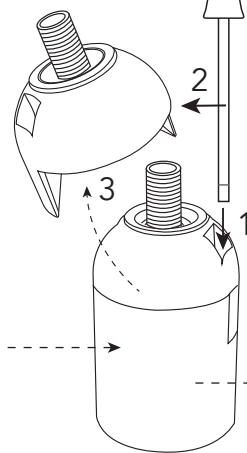
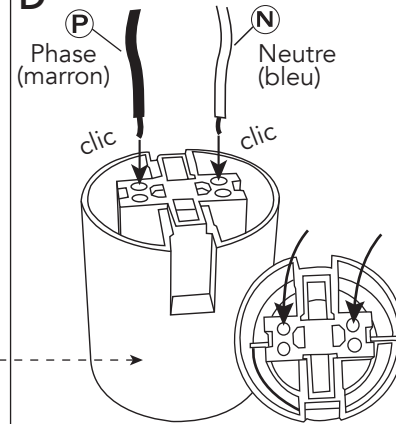
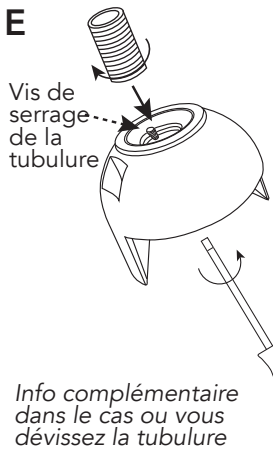
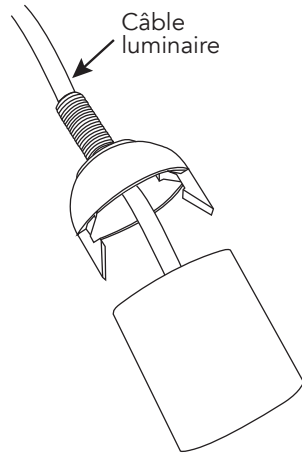

A MONTAGE

Avant de faire les branchements, coupez le courant à votre tableau électrique.

B**C****D****E**

Vis de serrage de la tubulure

F

Câble luminaire

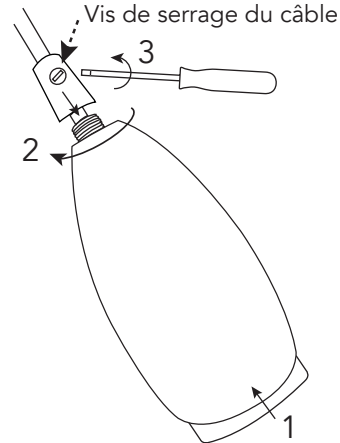
G

Vis de serrage du câble

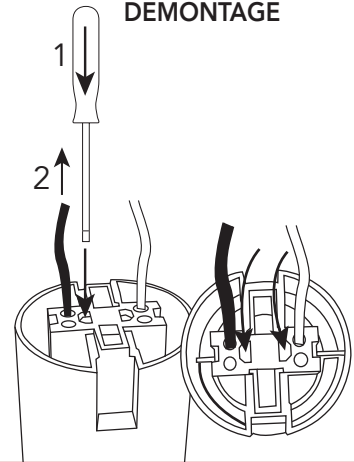
DEMONTAGE

Info complémentaire dans le cas où vous dévissez la tubulure