

A MONTAGE**B****C****D****E**

Vis de serrage de la tubulure

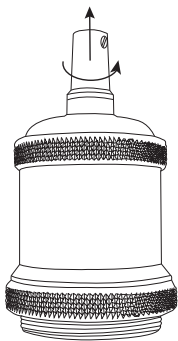
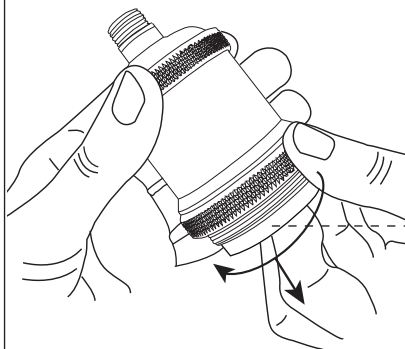
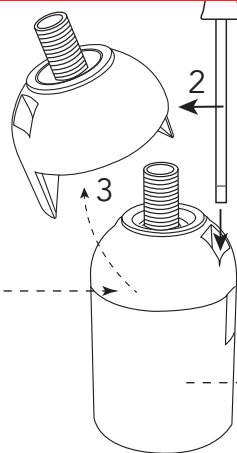
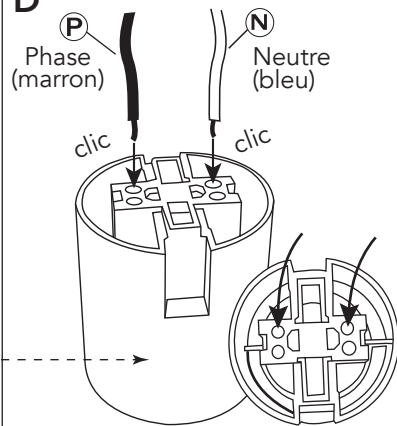
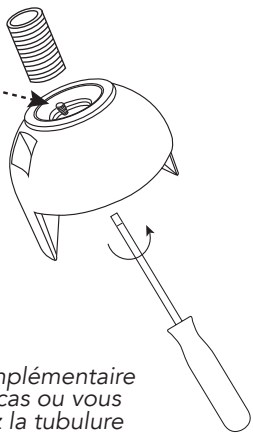
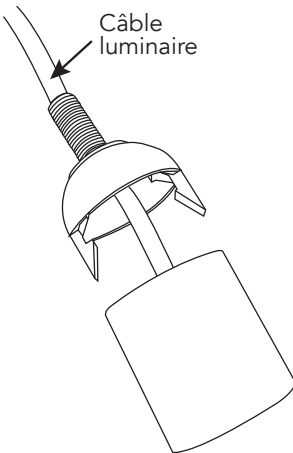
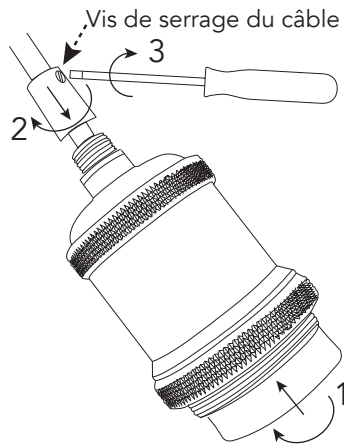

Info complémentaire dans le cas où vous dévissez la tubulure

F**G****DEMONTAGE**